

# Sliding & Folding Gate Hardware



[www.barrier-components.co.uk](http://www.barrier-components.co.uk)  
01708 891 515





# Cantilever Gate Hardware



Cantilever Gate Systems are a fantastic solution for high traffic, high security applications when controlling both pedestrian and vehicle access.

Its's main benefit is how a gate can span openings of up to 18m in length with a single gate panel, yet requires no floor mounted tracks that are susceptible to damage or a build up of debris.

By using high capacity and beautifully engineered rollers mounted to the side of the opening in conjunction with a track mounted to the underside of a gate, the gate passes over the rollers effortlessly and comes to a stop into a specially designed end stop. This then also holds the gate firmly in position and can be combined with a high security lock. Guidance at the top of the gate is achieved by

mounting a Guide Roller which is mounted on a post midway between the gates start and stop points.

We are also pleased to announce that the new lighter duty 800 series system is available to order. This is ideal for a more a light commercial or residential application with a max weight capacity of 300kg and a maximum opening of 5 metres.

Kits are available that consist of 2x Roller Units, 2x Guide Rollers, 2x End Stops and a Roller Guide Unit. Track is sold separately and comes in either 3 or 6 metre lengths.

Fixing Plates and Bolts are also available.

## Series 800, 900, 1000 & 2000



## Series 3000L



### Series 800

Max gate weight: 300kg

Max opening width: 5 meters

### Series 900

Max gate weight: 450kg

Max opening width: 7 meters

### Series 1000

Max gate weight: 600kg

Max opening width: 10 meters

### Series 2000

Max gate weight: 1200kg

Max opening width: 14 meters

### Series 3000L

Max gate weight: 1800kg

Max opening width: 16 meters

## Series 3000



### Series 3000

Max gate weight: 1800kg

Max opening width: 18 meters



# Sliding Gate Wheels & Tracks



FAC have a large range of tracked sliding hardware to suit most requirements which includes Gate Wheels, Guide Rollers, Gate Stops and Rail Profiles. A new innovation is our 2 or 3 leaf Telescopic Gate Kits which allow for a much smaller space adjacent to the opening. Kits do not include Rollers or Tracks. For further details please call our sales office.

## Standard Sliding Gate

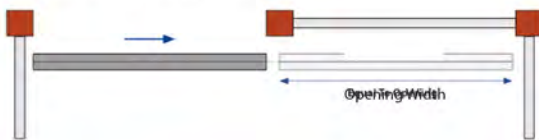

## 2 Leaf Telescopic Gate Kit

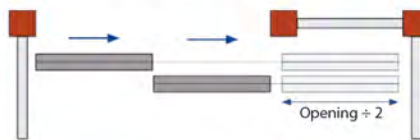

## 3 Leaf Telescopic Gate Kit

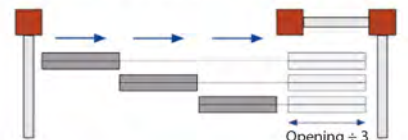

### Galvanised Wheel with Internal Support Bracket

Available with 1/2 round and V groove profiles and in various weight capacities upto 700kg per pair.



### Galvanised Wheel with External Support Bracket

Available with 1/2 round and V groove profiles and in various weight capacities upto 400kg per pair.



### Galvanised Wheel with Bearings

Available with 1/2 round and V groove profiles and in various weight capacities upto 700kg per pair.



### 816/820 Half Round Galvanised Steel Rail

For setting into concrete. Available in both 3m and 6m lengths.



### 716/720 Half Round Galvanised Steel Rail

Surface fixing. Available in both 3m and 6m lengths.



### 701 "V" Galvanised Steel Rail

Surface fixing. Available in both 3m and 6m lengths.



### Side Mounted Guide Brackets

Available with 4 roller adjustment and with extended side mouting plate. Check website for full range.

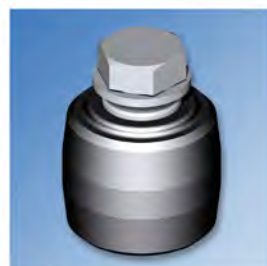

### Single Wheel Guide Rollers

Available in various sizes, with bolt fixing, "C" bracket fixing and with cover. Check website for full range.



### Single Wheel Long Guide Rollers

Available in various sizes, with bolt fixing or a "C" bracket fixing. Check website for full range.

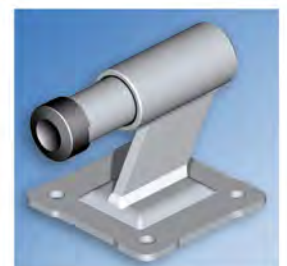

### Gate Stop

Options include base fix plate, weld fix and dampened action. Check website for full range.



# Guardian Cantilever Gate System

Telescopic  
Kits  
Available



The Guardian Cantilever Gate system uniquely holds its strength and remains on track, despite attack, even when the gate is partially open. The system has been tested to CE standards with a plan to gain PAS 68/69 approval. There are two Guardian Gate Kits, one is for gate up to 6000mm wide and one for gate up to 12000mm wide. Telescopic Kits are also available for Guardian and significantly reduce the amount of space required adjacent to the opening.

## Standard Guardian Cantilever Gate

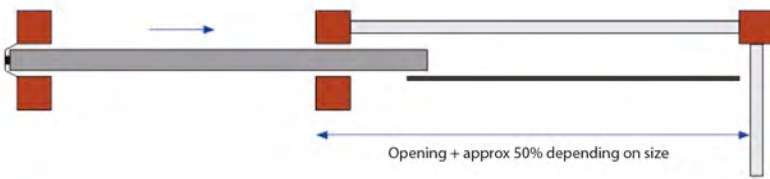

## 2 Leaf Telescopic Guardian Cantilever Kit

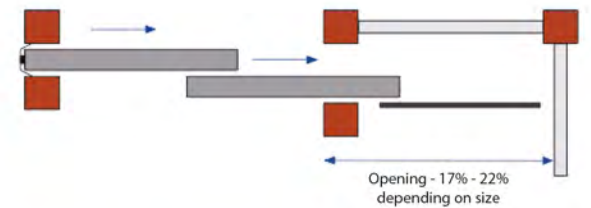

## Component Kit



1: Surface rollers



2: Guide rollers



3: Back rollers



4: Fixing template  
5: Fixing template



6: Front strikes

## Cantilever System Kit

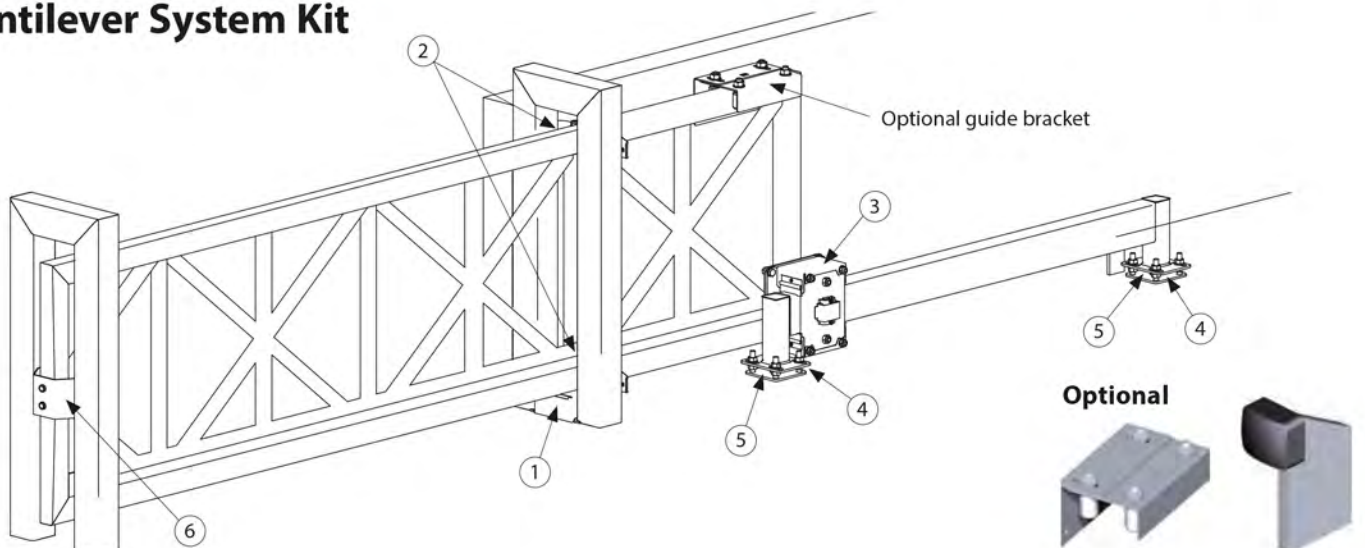

# The New FAC Bi-Folding Kit

- Compact
- Can be motorised
- Easy and fast installation
- Trackless

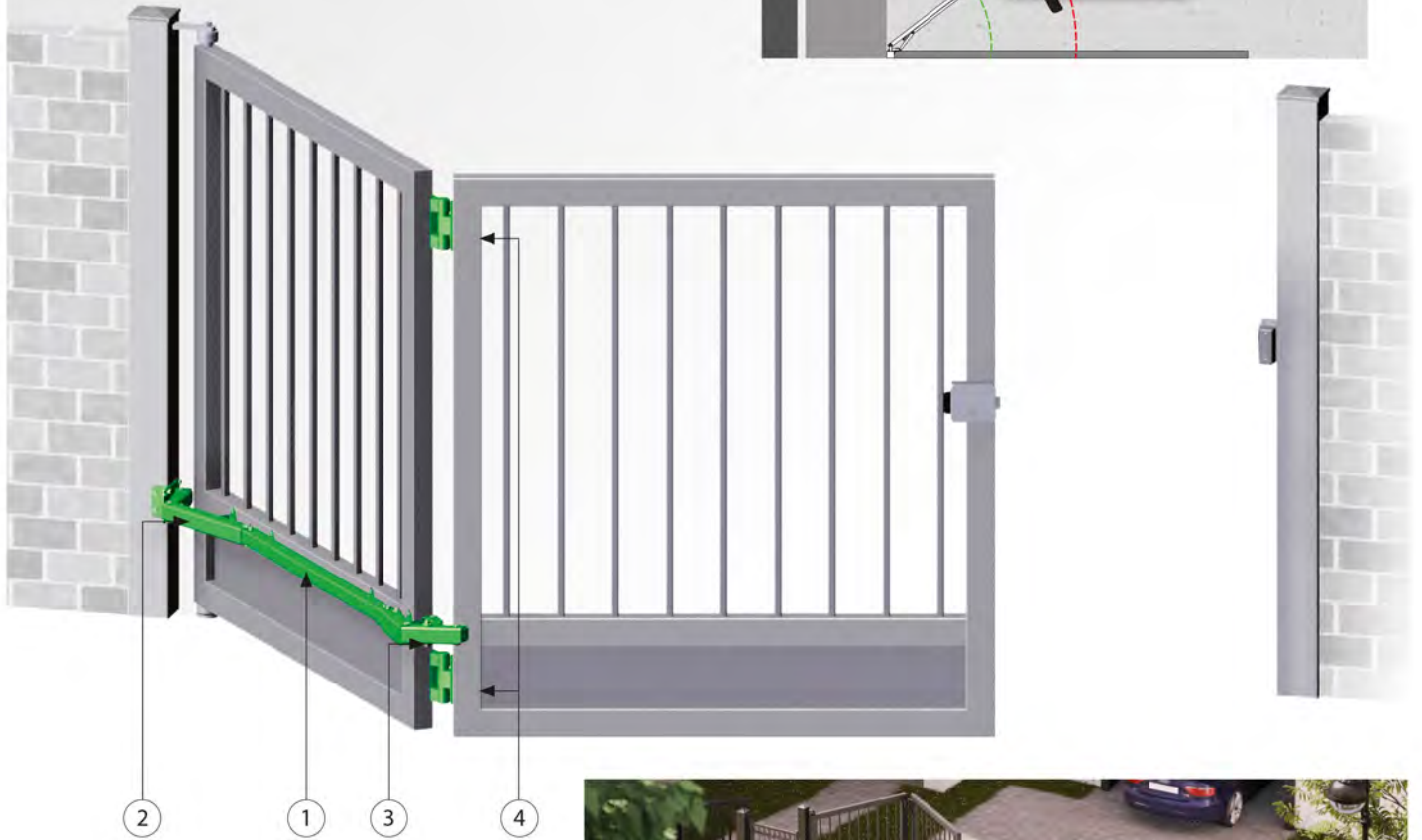
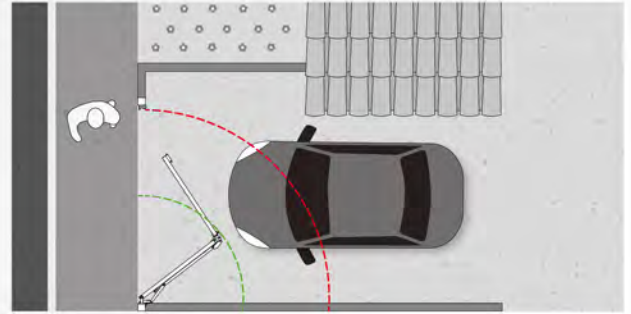

With limited space in residential housing the FAC Bi-Fold Gate Kit is the ideal solution.



## Component list

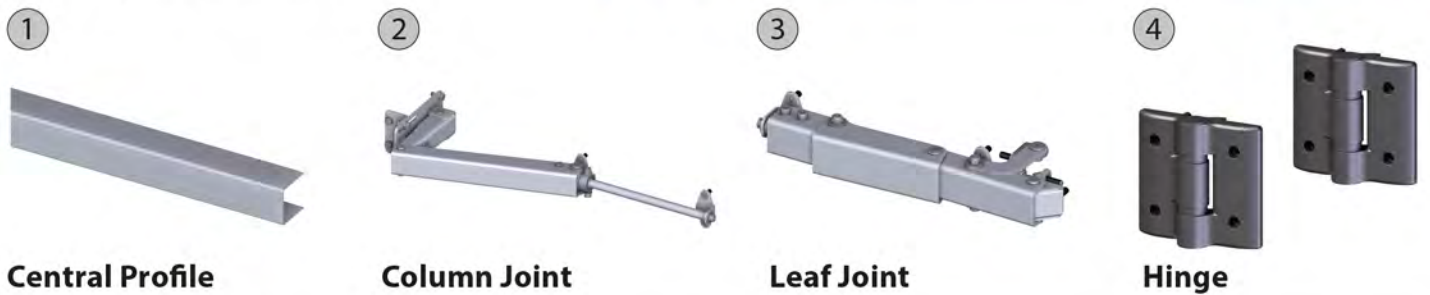

**Central Profile**

**Column Joint**

**Leaf Joint**

**Hinge**

**Kit 1**  
for single leaf



**Kit 2**  
for double leaves

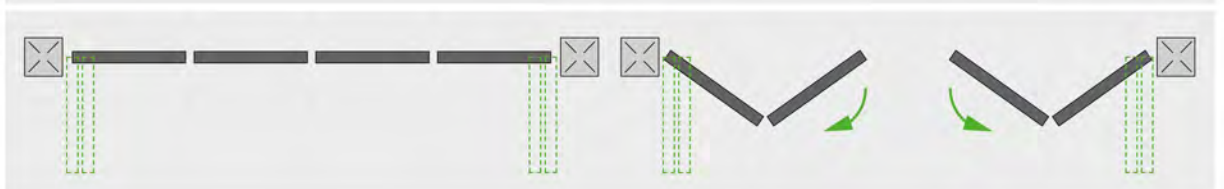



# Gate Accessories

Below is a selection of add on accessories suitable for all gate systems. These include Pull Handles, Flush Pulls, Locks & Bolts. For more technical details and to view our full range, please visit our website at [www.barrier-components.co.uk](http://www.barrier-components.co.uk) or contact our sales office.



## Bow Handle

561 - 230mm long  
564 - 345mm long

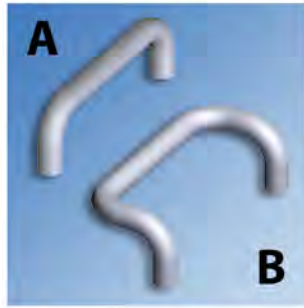

## A = Bow Handle

531 - 180mm centres  
534 - 280mm centres

## B = D Handle

280mm centres



## Flush Pull 511F

52mm wide x 115mm high

## Flush Pull 501F

90mm wide x 200mm high



## Sliding Gate Lock 350

60mm backset  
25mm wide faceplate



## Lock Box

Suits 350 sliding gate lock



## A = Strike Plate

Suits 350 sliding gate lock

## B = Strike Box

Suits 350 sliding gate lock



## Auto Bolt 42

306mm long

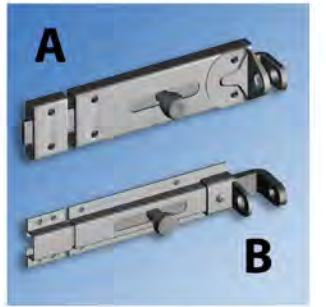

## A = Padbolt 285

183mm long 45mm high

## B = Padbolt 286

180mm long 57mm high

Barrier Components Ltd., established in 1987, is now one of the leading UK stockists of quality architectural hardware, supplying products to both commercial and residential markets. We provide a one-stop shop for weather seals, brush strips, glass hardware, sliding door hardware, gate hardware, shower hardware, swing doors and much more. Check out our website to download our other product brochures.



## Barrier Components Ltd

Unit 8 Dolphin Way Dolphin Point Purfleet  
Essex RM19 1NR  
t: 01708 891 515 f: 01708 891 516  
sales@barrier-components.co.uk  
www.barrier-components.co.uk

