



# Vistafold Elite - Bottom Rolling Installation Instructions



## Specifications:

Maximum Leaf Width: 90kg  
Maximum Leaf Height: 2700mm

Maximum Leaf Width: 900mm  
Leaf Thickness: 44-56mm

**Step 1 – Select required layout. For bi-parting systems such as a 3+3 door system simply select 2 layouts**

**Step 2 – Ensure your doors are made to the correct size for the opening**

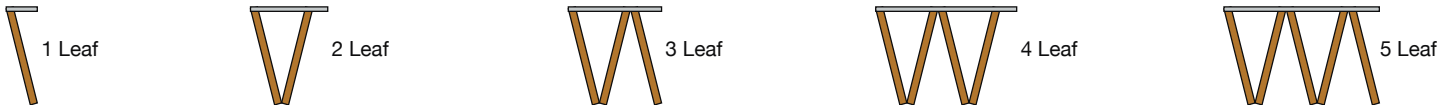

## Odd Leaf - Layout & Calculations

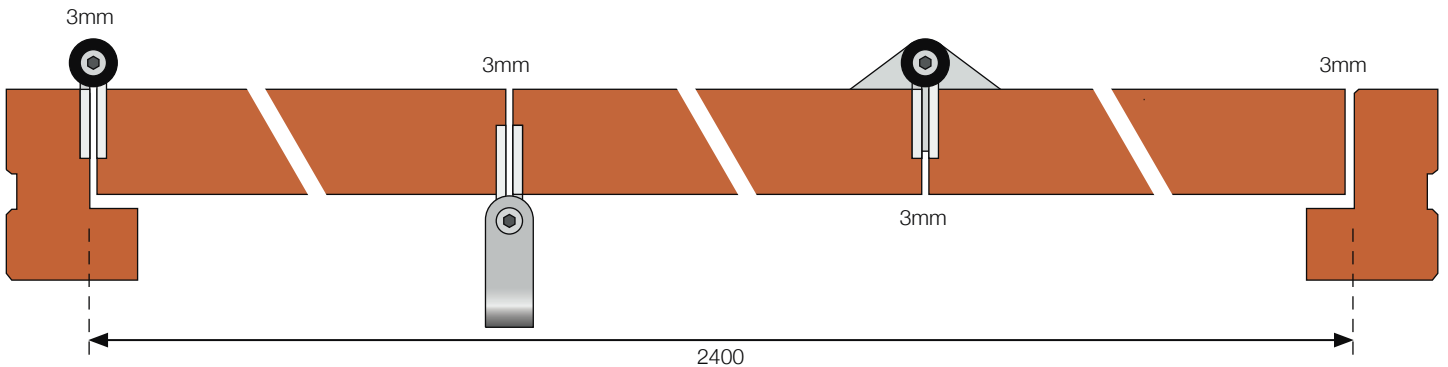

### Example based on above diagram

To work out the leaf sizes for an even leaf system simply apply the calculation below:

Finished opening minus all clearances between leaves and jambs  $\div$  3 = leaf width for all 3 leaves.

Therefore, the above example would work out that each leaf width = 796mm

## Even Leaf - Layout & Calculations

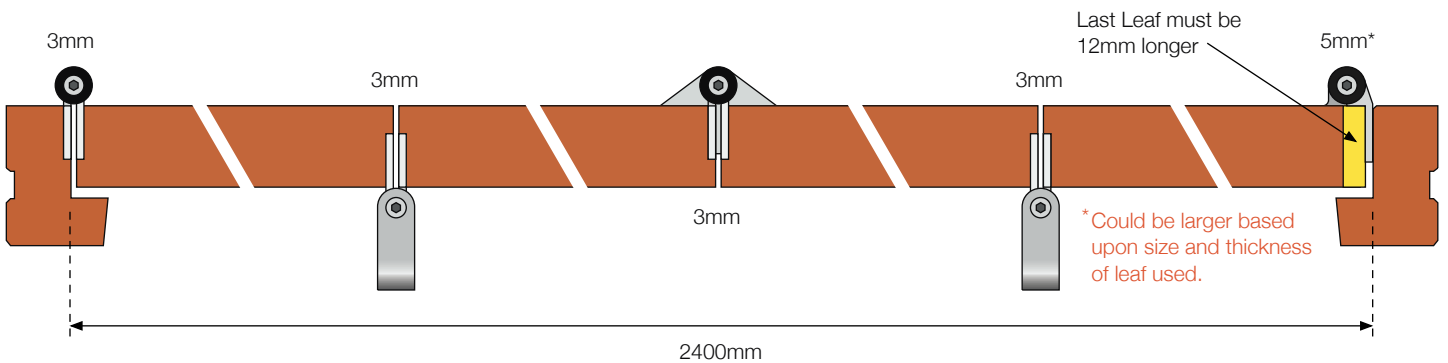

### Example based on above diagram

To work out the leaf sizes for an even leaf system simply apply the calculation below:

Finished Opening minus all clearances between leaves and jambs (note 5mm minimum gap for closing jamb), minus a further 12mm and then divide by 4. Then re-apply the 12mm to the last leaf.

Therefore, the above example would work out at 3 leaf widths = 592mm and the end leaf would be 604mm.

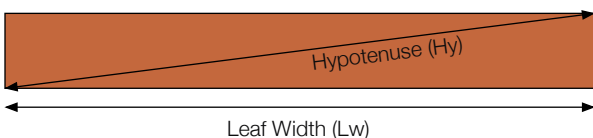

If the hypotenuse (Hy) of the leaf is greater than the width (Lw) x 1.003 then a risk of camming would exist upon the closing of even leaf layouts. To counter this a larger clearance between the last leaf and closing jamb may be needed based upon your layout.

## Calculating Leaf Height

To calculate the leaf height simply measure the finished opening and subtract 10mm from total. This will give you the correct height for the leaves.

## Hardware Notching Details

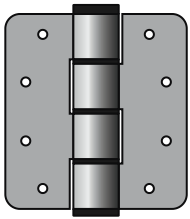

### Butt Hinge

Hinge flap thickness: 4mm Hinge flap corners: 6.5mm radius  
Hinge Flap Height: 86mm Hinge flap Width: 30mm

Please note that all hinge flaps apart from even leaf hardware are the same.

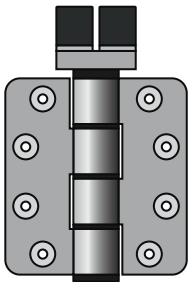

### Intermediate Top Guide

Sizes of the notches are shown on the diagram. The corners inside the cut out can have a 5mm radius if preferred.

Please note that the height of the cut out is 8.5mm

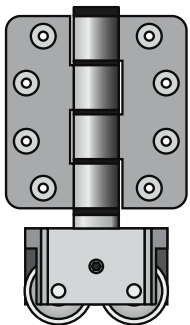
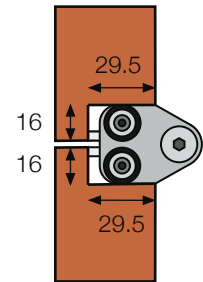

### Intermediate Bottom Roller

Sizes of the notches are shown on the diagram. The corners inside the cut out can have a 5mm radius if preferred.

Please note that the height of the cut out is 8.5mm

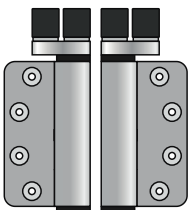
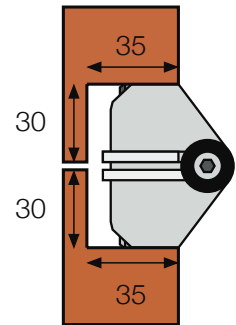

### Even Top Guides

Sizes of the notches are shown on the diagram. The corners inside the cut out can have a 5mm radius if preferred.

**Please note that the height of the cut out is 8.5mm and that the hinge flaps are surface fixed.**

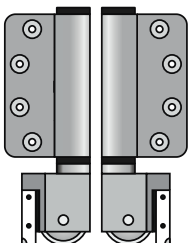
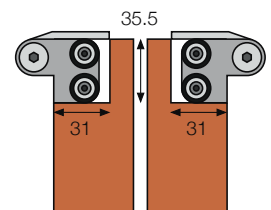

### Even Bottom Rollers

Sizes of the notches are shown on the diagram. The corners inside the cut out can have a 5mm radius if preferred.

**Please note that the height of the cut out is 36mm and that the hinge flaps are surface fixed.**

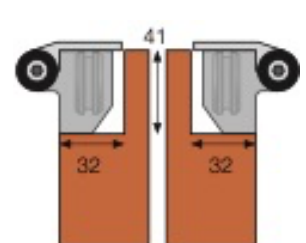

### Flush Bolts

Ideally the flush bolt faceplate should be recessed flush into the door for added durability and aesthetics.

The faceplate has a 18mm radius at the top.

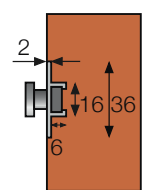

## Hardware Location

Please consider when setting out the hardware that the hinge placement when attached to a guide or bottom roller is higher/lower than standard hinges would normally be. With that in mind ensure that internal hinges are not placed too high/low in case they foul the top and bottom rebates. We would recommend they are placed with 10mm tolerance to the rebates to allow for potential adjustment.

## Weatherseal

We recommend AQ21 (or similar) to be used around the door frame in the same manner as you would seal a regular externally opening door.

In between each panel we suggest using the AQ63 in a double line on each of the joints between panels to ensure maximum weather protection. This can also be applied to the leaf edge on the hinged side and the closing end on even leaf layouts if desired.

Brush strips are a great idea to assist with keeping debris from being pushed under the doors into the bottom track and can also assist weathering where a non-rebated cill is required.

## Assembly Details

You can use a standard door frame design when using Vistafold Elite with only small modifications to allow for the track and channel to be installed, which keeps the overall size to around 100mm (4") wide. This also allows you to match the design of the system to existing doors on site.

You can also make the system with a flat threshold if required. However, weather proofing this kind of application can be more difficult. We would recommend using brush strip at the base of the door and that the external floor has a slight gradient away from the door so that water does not stand and capillate under the door. If possible, a French drain or similar on the external side would be a perfect solution. If you need advice on this kind of installation, please call for advice.

Mount the track & channel into the frame. Ensure all screws are fully countersunk in the top channel. Remember that odd number leaf systems do not require track under the free-swinging door. In these cases, position tracks & channel so that the end of the track aligns with the guide & roller resting positions when doors are in the closed position.

Mount the 1st leaf to the supporting jamb with 3 hinges. Flush bolts or Vistalock should also be fixed to this door (unless this a single door for access only).

2 Leaf Layout - Mount 2nd leaf to 1st leaf with 2 hinges & 1 hinge handle in centre. Ensure doors are supported until end roller & guides are installed. Ensure rollers and guides run freely.

3 Leaf Layout - Mount 3rd leaf to 2nd leaf with 1 top guide, 1 hinge & 1 bottom roller. Ensure rollers and guides run freely. Flush bolts or Vistalock should also be fixed to this door (unless this the last door and used as a swing door).

4 Leaf Layout - Mount 4th leaf to 3rd leaf with 2 hinges & 1 hinge handle in centre. Ensure doors are supported until end roller & guides are installed. Ensure rollers and guides run freely.

5 Leaf Layout - Mount 5th leaf to 4th leaf with 1 top guide, 1 hinge & 1 bottom roller. Ensure rollers and guides run freely.

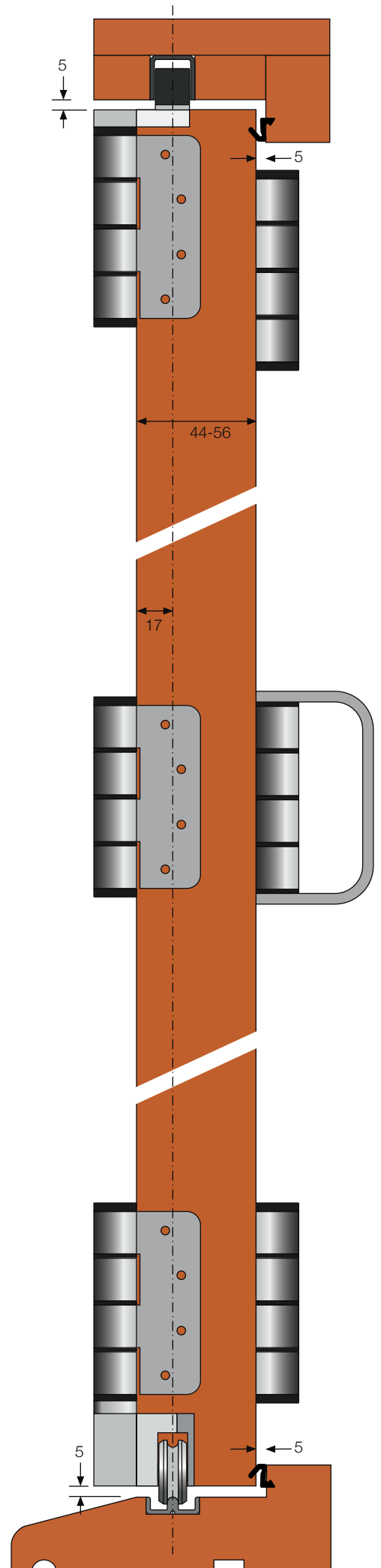

You have now installed one suite. If you have 2 suites meeting, you must now repeat the above steps.

Finally, if you have a swing door, install the multi point lock and handle to finish the system.

Place a magnetic holdback catch between any swing leaf and its adjoining leaf so that the door is secure during folding process. Not doing so could result in injury or damage to the system.

### Maintenance & Adjustment

Bottom rolling systems hardly ever require height adjustment. However, if adjustment is required simply open the system to expose the rear of the roller block and release the grub screw using a 3mm allen key. Then using a flat spanner turn the collar under the hinge flap until required height is reached. Re-tighten grub screw and then test system.

Should you require adjustment for the width, use hinge packers (by others) to achieve required amount of movement.

The only maintenance required is to periodically clean the hardware in a mild soapy water and ensure all tracks and channels are free from debris.

### Alternative Options

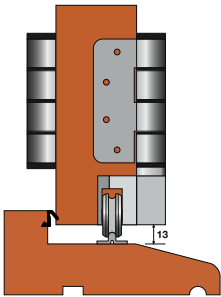

#### Surface Mount Track

There is an optional face fix bottom track available (814la), however we recommend the recessed variant for aesthetic reasons and when the Vistalock system is used. Also please note the larger 13mm gap required at the bottom of the door.

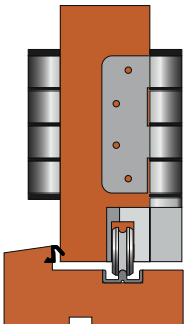

#### Internally Folding Door Layout

You can also design the system to be inward folding using a similar style of frame detail as shown here. Drip bars could be added for further protection if they do not impede on the folding action of the doors.

We would also recommend that the hinge handle is replaced with a standard Butt hinge. Flush pull handles are available for this configuration if required.

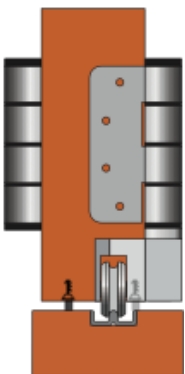

#### Flat Threshold

Vistafold Elite can be used for a flat threshold with no rebate. In this instance we would recommend using double brush strip seals on the bottoms of the door to restrict water and wind ingress. We would also suggest the external floor slopes away from the doors at a slight gradient. A French drain across the front of the doors would also assist in keeping water away.

Ideally, we would suggest flat thresholds are used where 100% weather proofing is not required, such as terrace areas and garden rooms.

### Help & Support

Vistafold Elite should prove simple to install, easy to use, and extremely durable. However, should you have any issues during installation or use, please call us for help and support. With over 25 years of experience in folding sliding doors, our experts can give you all the information and support needed to tackle any issues. If help is required, please call us on 01708 891515 or email us at [sales@barrier-components.co.uk](mailto:sales@barrier-components.co.uk)