

# 3WAY ADJUSTABLE CONCEALED HINGE



# HES3D-160



PAT.P

- 3 WAY adjustment function allows vertical, horizontal, and depth adjustment after hinge installed
- Easy installation / removal
- Supplied with stainless steel flat head screw
- Cover hides all screw heads for clean appearance
- Door weight: Max. 45kg (88lbs) / 2pcs
- Door Thickness: Min. 35mm (1-3/8")
- Max. Door Size: H 2000mm x W 900mm (H 78-47/64" x W 35-7/16")

Item No.	Finish / Color
HES3D-160SL	Matte Silver
HES3D-160GL	Matte Gold

Item No.	Weight (g)	Box (pcs)	Carton (pcs)
HES3D-160SL	700	2	-
HES3D-160GL			

No.	Part Name	Material	Finish / Color
①	Body	Zinc Alloy	Matte Silver Matte Gold
②	Base Frame	Zinc Alloy	
③	Arm	Aluminum	-
④	Shaft	304 Stainless Steel	-
⑤	Cover	ABS	Matte Silver, Matte Gold

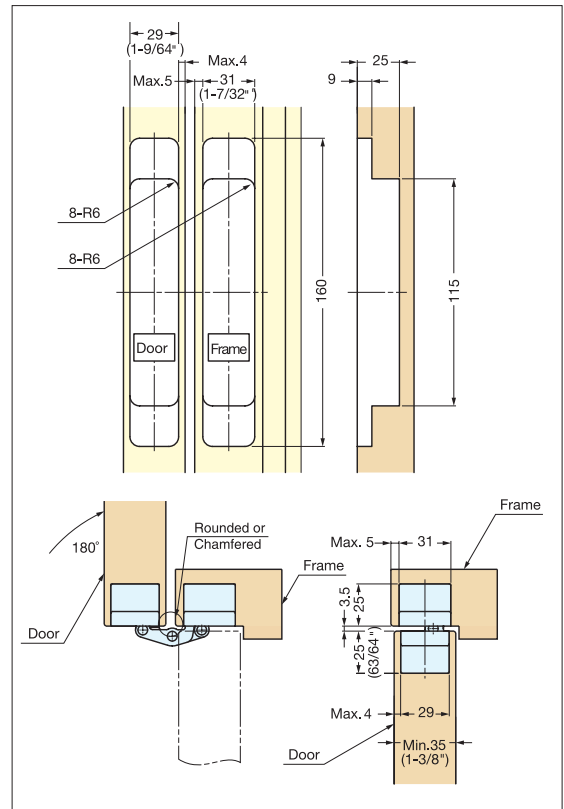
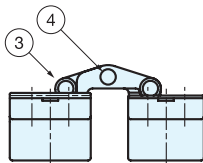
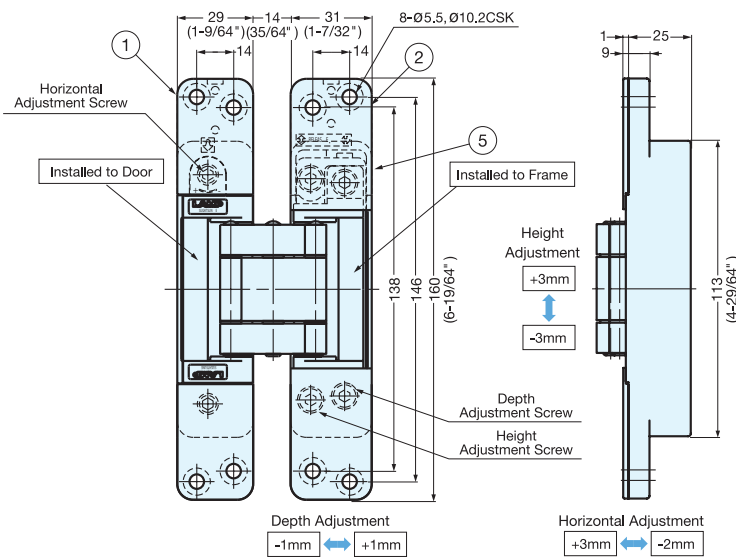

Bore Dimensions

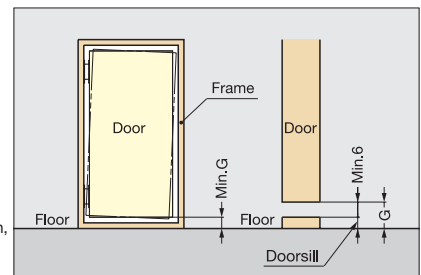

To determine the door and frame dimension, (G) must be taken into account.  
G = Min. 6mm + doorsill

# 3WAY ADJUSTABLE CONCEALED HINGE



# HES3D-190



PAT.P

- 3 WAY adjustment function allows vertical, horizontal, and depth adjustment after hinge installed
- Easy installation / removal
- Successfully passed 200,000 open / close private cycle tests
- Available in Matte Silver or Matte Gold finish
- Supplied with stainless steel flat head screw (Screw head painted)
- Door weight: Max. 70kg (154lbs) / 2pcs
- Door Thickness: Min. 36mm (1-27/64")
- Max. Door Size: H 2400mm x W 900mm (H 94-31/64" x W 35-7/16")

Item No.	Finish / Color		
HES3D-190SL	Matte Silver		
HES3D-190GL	Matte Gold		
Item No.	Weight (g)	Box (pcs)	Carton (pcs)
HES3D-190SL	940	2	12
HES3D-190GL			
No.	Part Name	Material	Finish / Color
①	Body	Zinc Alloy	Matte Silver Matte Gold
②	Base Frame	Zinc Alloy	
③	Arm	Aluminum	
④	Shaft	304 Stainless Steel	-
⑤	Cover	ABS	Matte Silver, Matte Gold

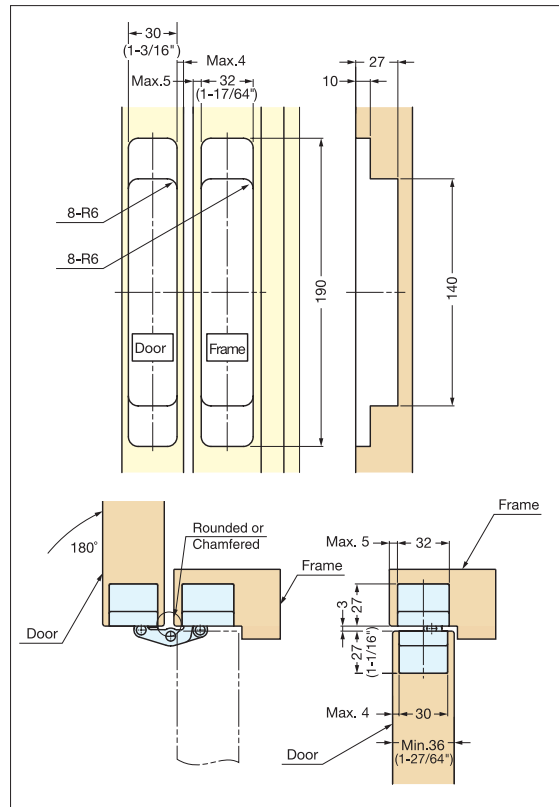
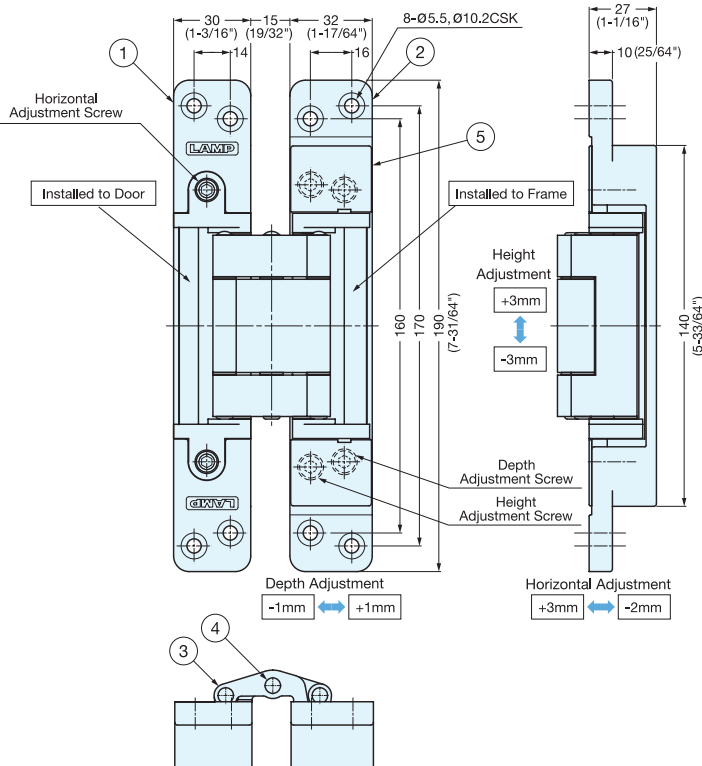

Bore Dimensions

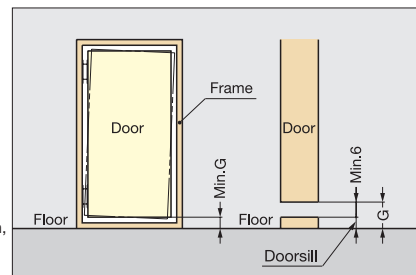

To determine the door and frame dimension, (G) must be taken into account.  
G = Min. 6mm + doorsill

### a. Detailed View

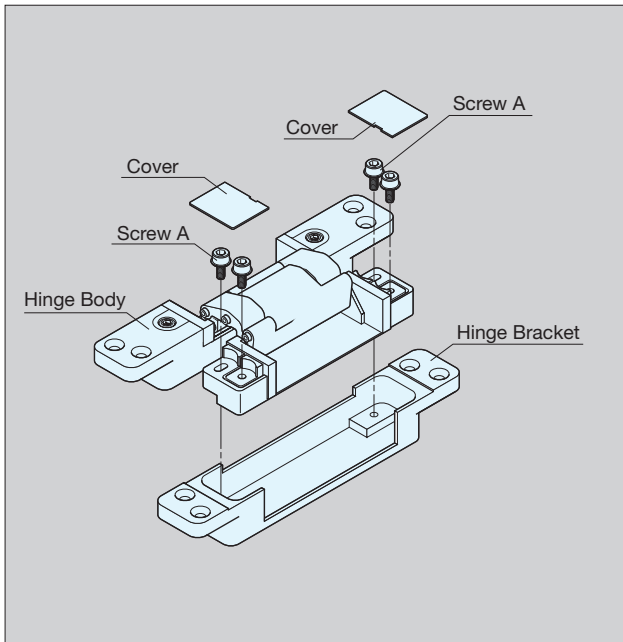

#### For Easy Installation

1. Separate parts as shown in picture "a".
2. Screw on the Hinge Body to door, and Hinge Bracket to door frame.
3. As shown in picture "b", insert Hinge Body straight into Hinge Bracket. Bracket will temporarily hold the Body for easy installation.
4. Use "screw A" to fix Body on Bracket.
5. Adjust horizontally by turning "screw B".
6. Loosen "screw A" for vertical adjustment. Tighten "screw A" after vertical adjustment completed.
7. For depth adjustment, loosen "screw C" (one turn). Tighten "screw C" after completed.
8. Snap on plastic covers after all above completed.



### b. Installation

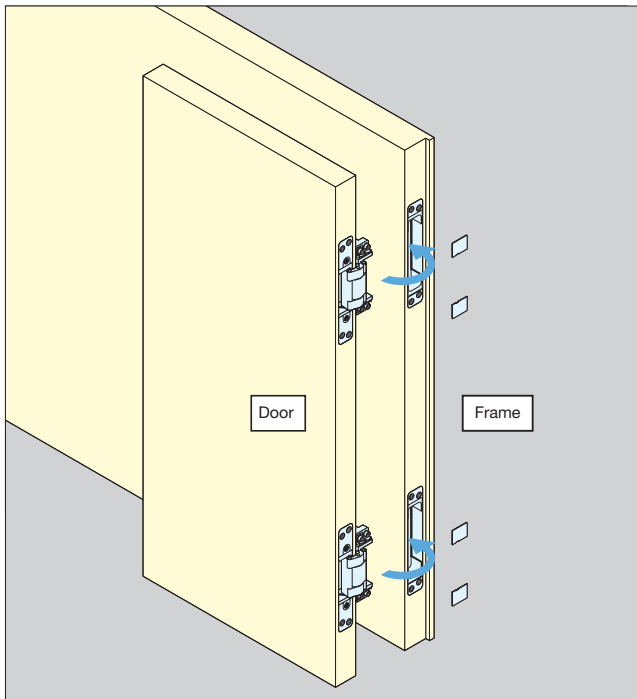

### c. 3WAY Adjustment

